

## MODÈLES DE PORTE / DOOR MODELS

SÉRIE 1  
SERIE 1



SÉRIE 2  
SERIE 2



SÉRIE EURO  
SERIE EURO



SÉRIE ÉLÉMENT  
SERIE ELEMENT



SÉRIE ÉLÉVATION  
SERIE ELEVATION



### LÉGENDE LEGEND

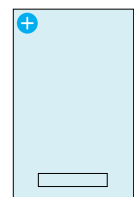

### + OPTIONS D'INSERTION

LES PORTES IDENTIFIÉES PAR UN + SONT DISPONIBLES AVEC L'OPTION D'INSÉRER UNE COULEUR SUPPLÉMENTAIRE. Référez-vous au guide des couleurs

#### NOMENCLATURE DE LA COMMANDE

Porte + Code de couleur + Code de couleur de l'insertion  
Ex.: P-105-A-K18-0720

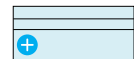

### + INSERTION OPTIONS

INSERTION OPTIONS ARE AVAILABLE FOR THE DOORS IDENTIFIED BY + Refer to the colours guide

#### ORDER PRODUCT CODE

Door + Color code + Insertion options color code  
Ex.: P-105-A-L560-0720



← ↑ ↓ → Les flèches indiquent le sens de la texture de bois ou du motif  
The arrows indicates woodgrain or pattern

# FUSION COLLECTION

CHOIX DE COULEURS / COLOURS SELECTION



+ OPTIONS D'INSERTION / INSERTION OPTIONS

## TOPMATT FENIX

### INFORMATIONS TECHNIQUES / TECHNICAL INFORMATION

	STEVENS	UNIBOARD	TAFISA	MINIMUM		MAXIMUM	
				HAUTEUR / HEIGHT	LARGEUR / WIDTH	HAUTEUR / HEIGHT	LARGEUR / WIDTH
<b>SÉRIE 1 / SERIE 1</b>							
Modèles / Models 101, 105, 109	X	X	X	6"	7"	95"	47"
Modèles / Models 102, 104, 106	X	X	X	6"	7"	47"	95"
Modèles / Models 103	X	X	X	6"	7"	47"	47"
Modèles / Models 107	X	X	X	15"	7"	95"	47"
Modèles / Models 108	X	X	X	15"	7"	47"	95"
<b>SÉRIE 2 / SERIE 2</b>							
Modèles / Models 201, 203, 211		X	X	6"	7"	95"	47"
Modèles / Models 202, 204, 212		X	X	6"	7"	47"	95"
Modèles / Models 309		X	X	6"	8"	95"	47"
Modèles / Models 310		X	X	6"	8"	47"	95"
Modèles / Models 311		X	X	8"	6"	95"	47"
Modèles / Models 312		X	X	8"	6"	47"	95"
<b>SÉRIE EURO / SERIE EURO</b>							
Modèles / Models 105   1, 2, 4, 5, 6, 7		X	X	6"	7"	95"	47"
Modèles / Models 106   1, 2, 4, 5, 6, 7		X	X	6"	7"	47"	95"
Modèles / Models 105 et/and 106   11, 22, 44, 55, 66		X	X	6"	7"	47"	47"
Modèles / Models 105   3	X	X	X	6"	7"	95"	47"
Modèles / Models 106   3	X	X	X	6"	7"	47"	95"
Modèles / Models 105 et/and 106   33	X	X	X	6"	7"	47"	47"
<b>SÉRIE ÉLÉMENT / SERIE ELEMENT</b>							
Modèles / Models 105   A, B, D, E	X	X	X	6"	7"	95"	47"
Modèles / Models 106   A, B, D, E	X	X	X	6"	7"	47"	95"
Modèles / Models 105 et / and 106   AA, BB, DD, EE	X	X	X	6"	7"	47"	47"
Modèles / Models 105   F, G	X	X	X	8 ½"	6"	95"	47"
Modèles / Models 106   F, G	X	X	X	8 ½"	6"	47"	95"
Modèles / Models 105 et / and 106   FF, GG	X	X	X	8 ½"	6"	47"	47"
Modèles / Models 105   H	X	X	X	6"	8 ½"	95"	47"
Modèles / Models 106   H	X	X	X	6"	8 ½"	47"	95"
Modèles / Models 105 et / and 106   HH	X	X	X	6"	8 ½"	47"	47"
Modèles / Models 105   I	X	X	X	6"	14 ½"	95"	47"
Modèles / Models 106   I	X	X	X	6"	14 ½"	47"	95"
Modèles / Models 105 et / and 106   II	X	X	X	6"	14 ½"	47"	47"
<b>SÉRIE ÉLÉVATION/ SERIE ELEVATION</b>							
Modèles / Models P-405, P-505		X		6"	7"	95"	47"
Modèles / Models P-406, P-506		X		6"	7"	47"	95"
Modèles / Models P-605, P-606			X	6"	7"	95"	47"
Modèles / Models P-605, P-606			X	6"	7"	47"	95"

Plus de / More than  
**40 000**  
possibilités / possibilities

BANDE DE CHANT FUSIONNÉE AU LASER / BONDED LASER EDGE BANDING

**DÖRR**  
INDUSTRIES

1985 AR Décar  
Québec, QC, Canada G1N 3Z8  
info@industriesdorr.com  
T. 418 683-0700  
www.industriesdorr.com

SÉRIE 1 / SERIE 1  
SÉRIE 2 / SERIE 2  
SÉRIE EURO / SERIE EURO  
SÉRIE ÉLÉMENT / SERIE ELEMENT  
SÉRIE ÉLÉVATION / SERIE ELEVATION

+ OPTIONS D'INSERTION / INSERTION OPTIONS  
couleurs supplémentaires / additional colors

Offerts avec ou sans rainure en V.  
 (Pour commander, ajouter « V » après le code)  
 \*Rainure en V obligatoire pour couleurs unies.  
 Available with or without V groove.  
 (Add V to door code to order. Ex: P-101-V)  
 \*V groove is mandatory with solid colors.

## SÉRIE EURO / SERIE EURO

Portes / Doors

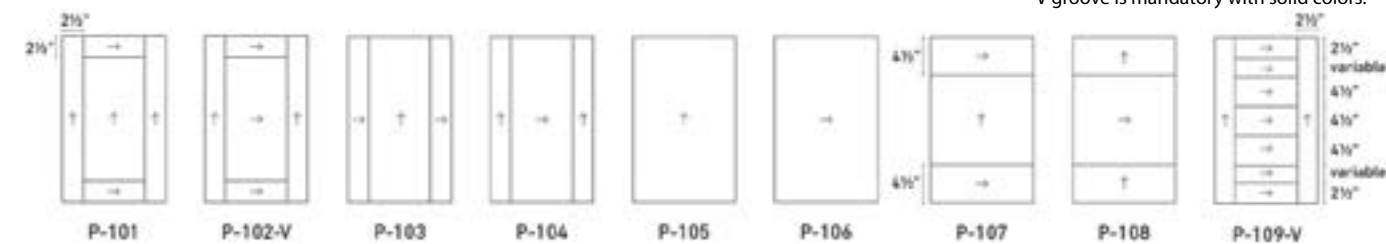

Portes vitrées / Glass doors

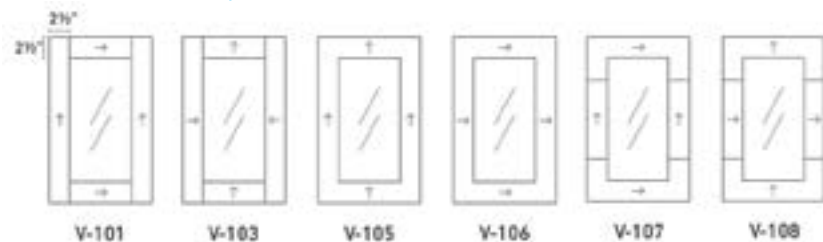

Façades / Drawers front

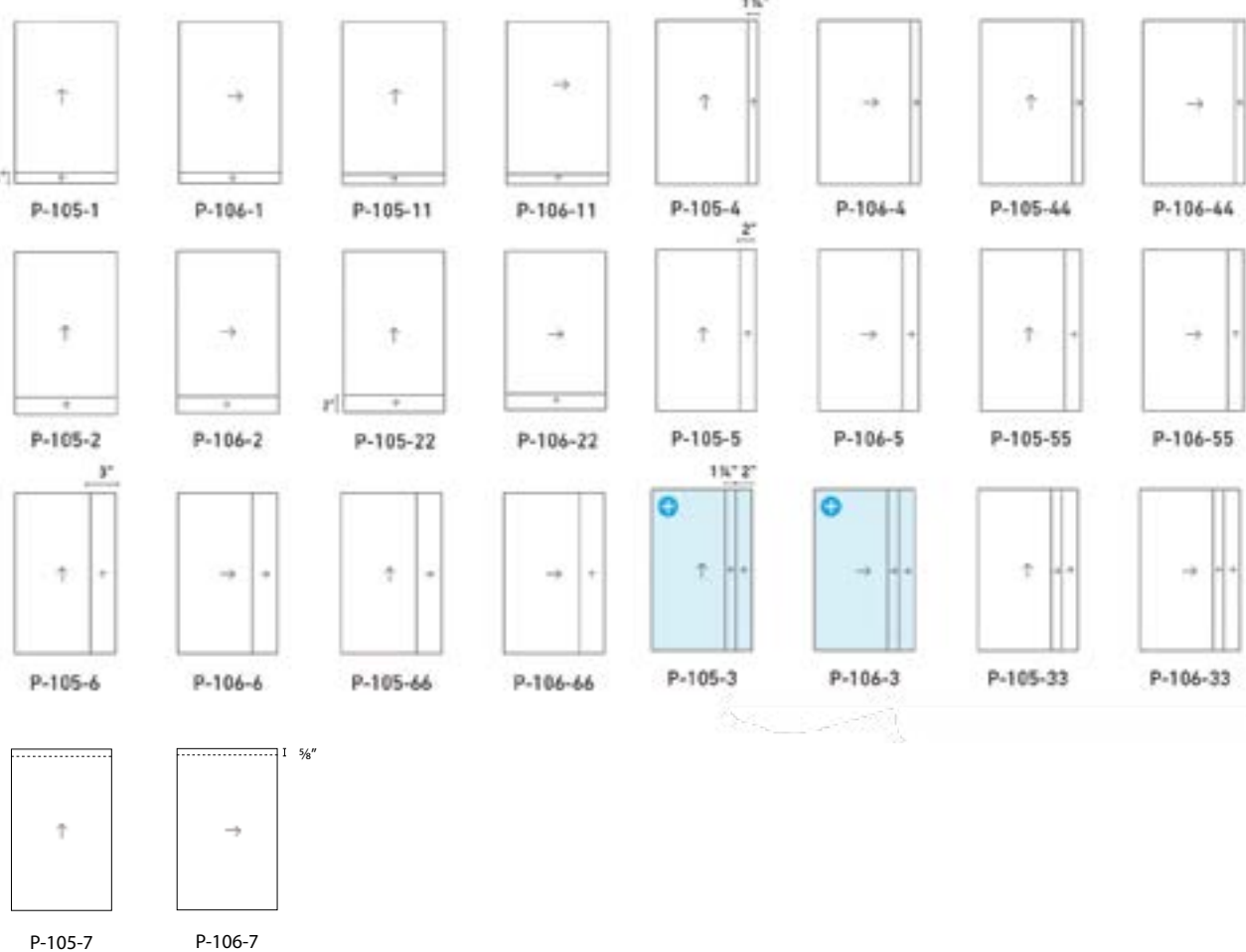
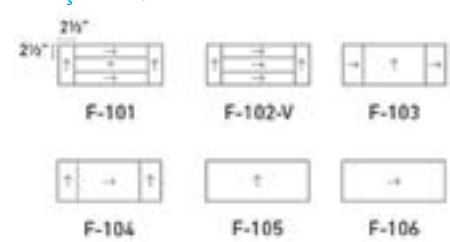

## SÉRIE 2 / SERIE 2 (Porte 2 niveaux / 2 level profile)

Portes / Doors

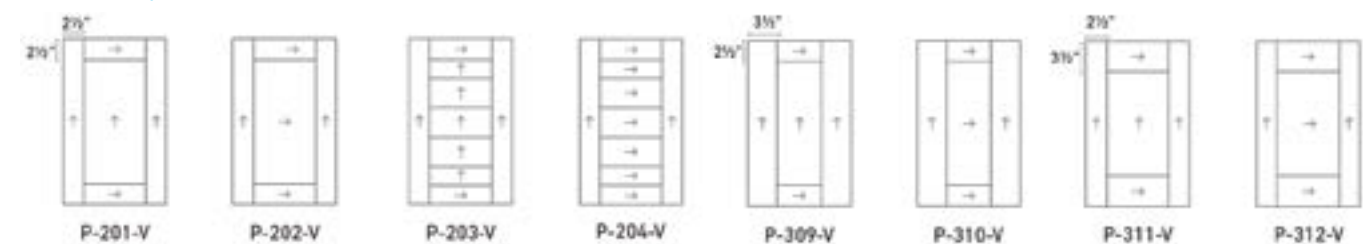

Portes vitrées / Glass doors

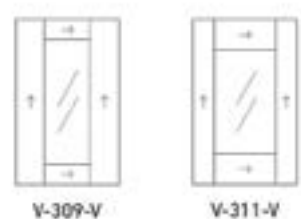

Façades / Drawers front

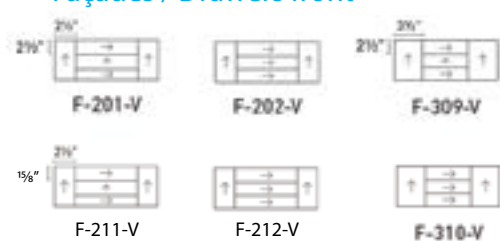

Façades / Drawers front

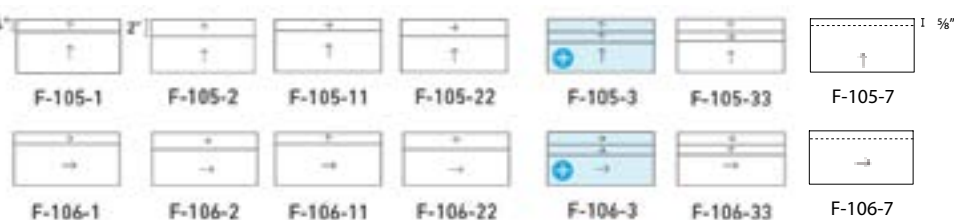

### Spécifications verrière / Glass door specifications

Pour le verre : déduire 4 1/8\"/>
 Glass insertion: Deduct 4 1/8\"/>

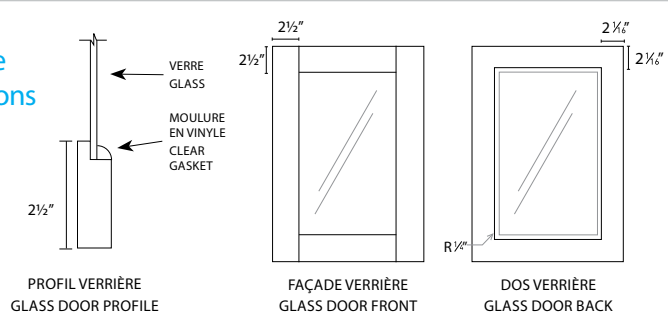

## SÉRIE ÉLÉMENT / SERIE ELEMENT

Portes / Doors

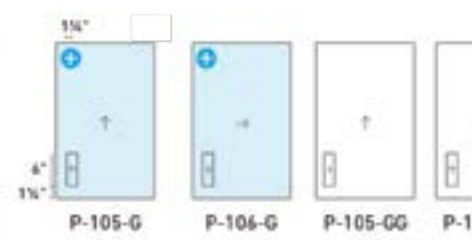
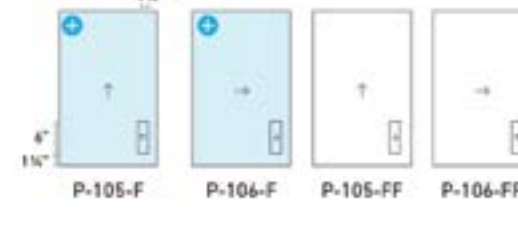
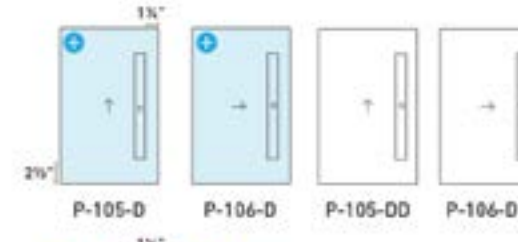
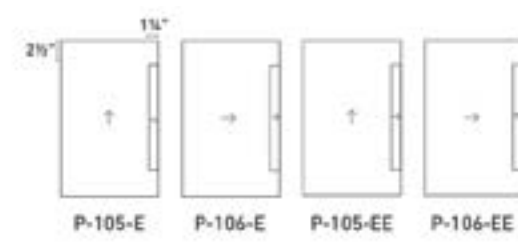

Façades / Drawers front

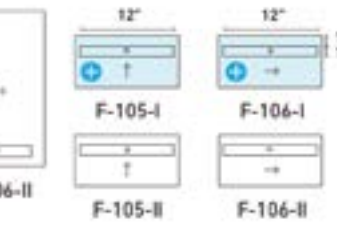
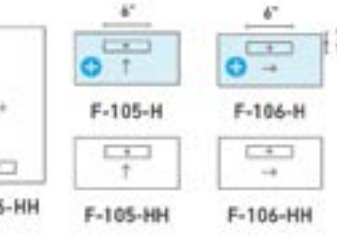
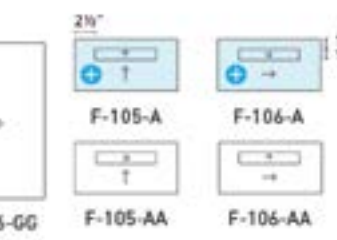
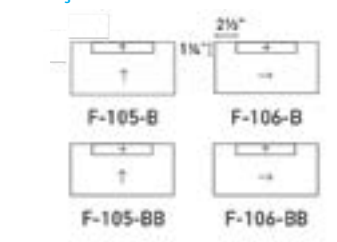

## SÉRIE ÉLÉVATION / SERIE ELEVATION

Portes / Doors

