

MODÈLES DE PORTE / DOOR MODELS



SÉRIE 1
SERIE 1



SÉRIE 2
SERIE 2



SÉRIE 2.0
SERIE 2.0



SÉRIE EURO
SERIE EURO



SÉRIE ÉLÉMENT
SERIE ELEMENT



SÉRIE ÉLÉMENT
SERIE ELEMENT



VOIR LES CHOIX DE COULEURS DANS LA SECTION
 + OPTIONS D'INSERTION couleurs supplémentaires
 REFER TO COLOR SELECTION SECTION
 + INSERTION OPTIONS additional colors

← ↑ ↓ → Les flèches indiquent le sens de la texture de bois ou du motif
 The arrows indicates woodgrain or pattern

FUSION | COLLECTION



DÖRR
INDUSTRIES

1985 AR Décarý
 Québec, QC, Canada G1N 3Z8
 info@industriesdorr.com
 T. 418 683-0700 / F. 418 683-0766
 www.industriesdorr.com

SÉRIE 1 / SERIE 1
 SÉRIE 2 / SERIE 2
 SÉRIE 2.0 / SERIE 2.0
 SÉRIE EURO / SERIE EURO
 SÉRIE ÉLÉMENT / SERIE ELEMENT

+ OPTIONS D'INSERTION / INSERTION OPTIONS
 couleurs supplémentaires / additional colors

POUR LE CHOIX DE COULEURS, SE RÉFÉRER AU GUIDE DES COULEURS /
 FOR COLOURS SELECTION, REFER TO THE COLOURS GUIDE

CHOIX DE COULEURS / COLOURS SELECTION



+ OPTIONS D'INSERTION / INSERTION OPTIONS



INFORMATIONS TECHNIQUES /
 TECHNICAL INFORMATIONS

	STEVENS	UNIBOARD	TAFISA	MINIMUM		MAXIMUM	
				HAUTEUR / HEIGHT	LARGEUR / WIDTH	HAUTEUR / HEIGHT	LARGEUR / WIDTH
SÉRIE 1 / SERIE 1							
Modèles / Models 101, 105, 109	X	X	X	6"	7"	95"	47"
Modèles / Models 102, 104, 106	X	X	X	6"	7"	47"	95"
Modèles / Models 103	X	X	X	6"	7"	47"	47"
Modèles / Models 107	X	X	X	15"	7"	95"	47"
Modèles / Models 108	X	X	X	15"	7"	47"	95"
SÉRIE 2 / SERIE 2							
Modèles / Models 201, 203, 205, 206, 207, 208		X	X	6"	7"	95"	47"
Modèles / Models 202, 204		X	X	6"	7"	47"	95"
Modèles / Models 309		X	X	6"	8"	95"	47"
Modèles / Models 310		X	X	6"	8"	47"	95"
Modèles / Models 311		X	X	8"	6"	95"	47"
Modèles / Models 312		X	X	8"	6"	47"	95"
SÉRIE 2.0 / SERIE 2.0							
Modèles / Models 301		X	X	6"	7"	95"	47"
Modèles / Models 302, 303		X	X	6"	7"	47"	95"
Modèles / Models 304		X	X	6"	7"	47"	47"
Modèles / Models 305, 308		X	X	15"	6"	95"	47"
Modèles / Models 306		X	X	15"	6"	47"	95"
Modèles / Models 307		X	X	15"	6"	47"	47"
SÉRIE EURO / SERIE EURO							
Modèles / Models 105-1, 105-2, 105-4, 105-5, 105-6		X	X	6"	7"	95"	47"
Modèles / Models 106-1, 106-2, 106-4, 106-5, 106-6		X	X	6"	7"	47"	95"
Modèles / Models 105-11, 105-22, 105-44, 105-55, 105-66, 106-11, 106-22, 106-44, 106-55, 106-66		X	X	6"	7"	47"	47"
Modèles / Models 105-3	X	X	X	6"	7"	95"	47"
Modèles / Models 106-3	X	X	X	6"	7"	47"	95"
Modèles / Models 105-33, 106-33	X	X	X	6"	7"	47"	47"
SÉRIE ÉLÉMENT / SERIE ELEMENT							
Modèles / Models 105 A, B, D, E	X	X	X	6"	7"	95"	47"
Modèles / Models 106 A, B, D, E	X	X	X	6"	7"	47"	95"
Modèles / Models 105 et / and 106 AA, BB, DD, EE	X	X	X	6"	7"	47"	47"
Modèles / Models 105 F, G	X	X	X	8 ½"	6"	95"	47"
Modèles / Models 106 F, G	X	X	X	8 ½"	6"	47"	95"
Modèles / Models 105 et / and 106 FF, GG	X	X	X	8 ½"	6"	47"	47"
Modèles / Models 105 H	X	X	X	6"	8 ½"	95"	47"
Modèles / Models 106 H	X	X	X	6"	8 ½"	47"	95"
Modèles / Models 105 et / and 106 HH	X	X	X	6"	8 ½"	47"	47"
Modèles / Models 105 I	X	X	X	6"	14 ½"	95"	47"
Modèles / Models 106 I	X	X	X	6"	14 ½"	47"	95"
Modèles / Models 105 et / and 106 II	X	X	X	6"	14 ½"	47"	47"

SÉRIE 1 / SERIE 1 (Porte 1 niveau / 1 level profile)

Options

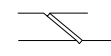

Offerts avec ou sans rainure en V.
(Pour commander, ajouter « V » après le code)
Available with or without V groove.
(Add V to door code to order)
Ex: P-101-V

Portes / Doors

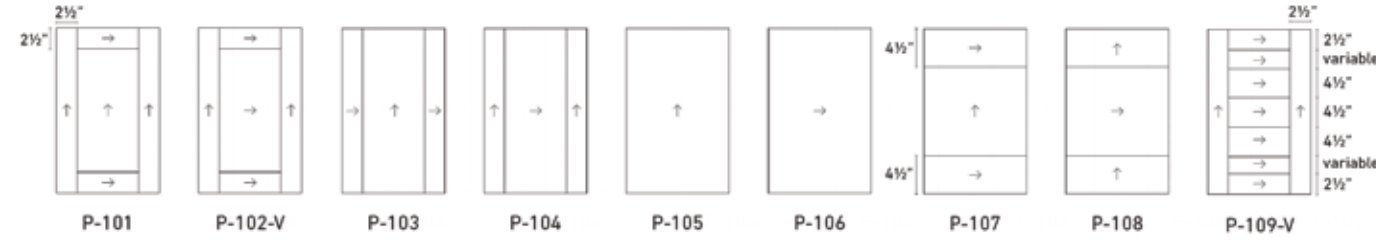

Portes vitrées / Glass doors

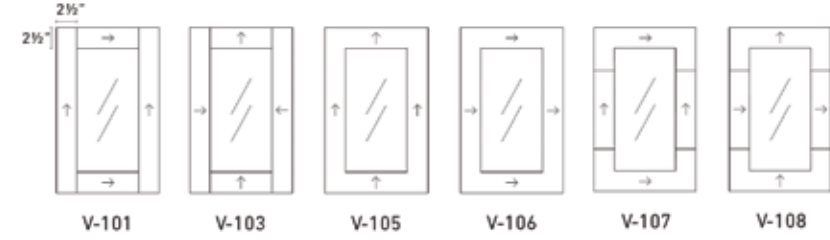

Façades / Drawers front

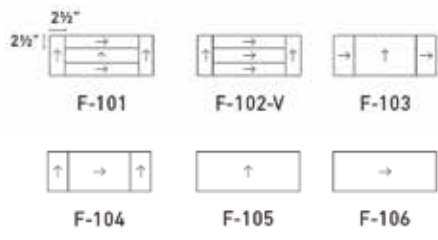

SÉRIE 2.0 / SERIE 2.0 (Porte 2 niveaux / 2 level profile)

Portes / Doors

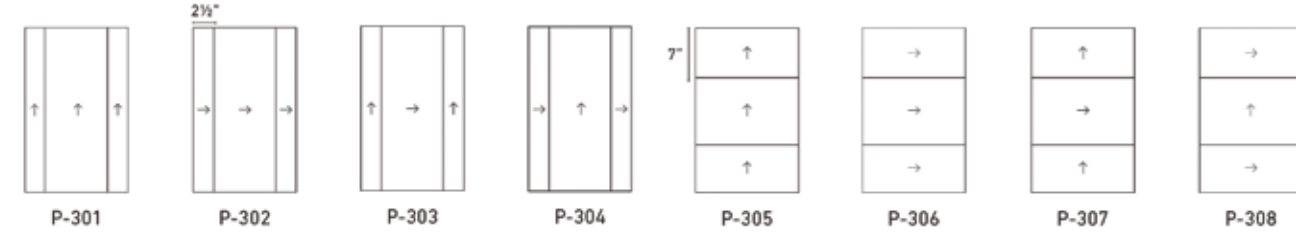

Façades / Drawers front



SÉRIE 2 / SERIE 2 (Porte 2 niveaux / 2 level profile)

Portes / Doors

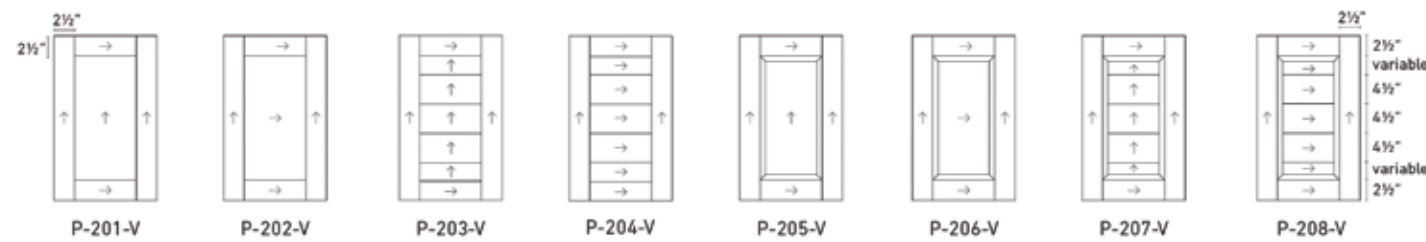

SÉRIE 2 / SERIE 2 (suite)

Portes / Doors

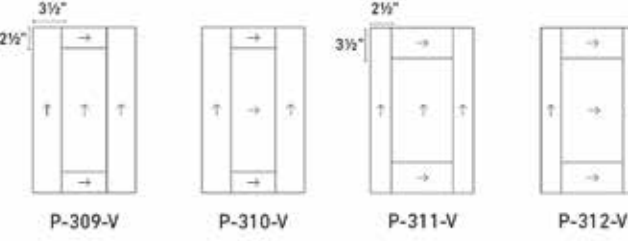

Portes vitrées / Glass doors

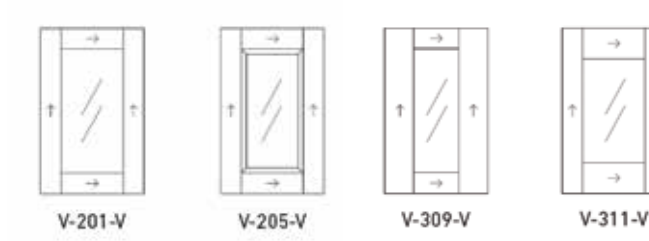

Façades / Drawers front

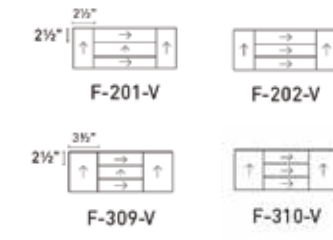

Spécifications verrière Glass door specifications

Pour le verre :
déduire 4 1/8" de
la hauteur et de
la largeur de la porte
Glass insertion:
Deduct 4 1/8" for
the height and width

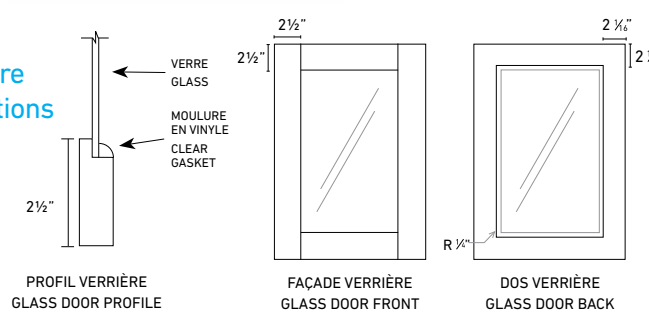

SÉRIE EURO / SERIE EURO

Portes / Doors

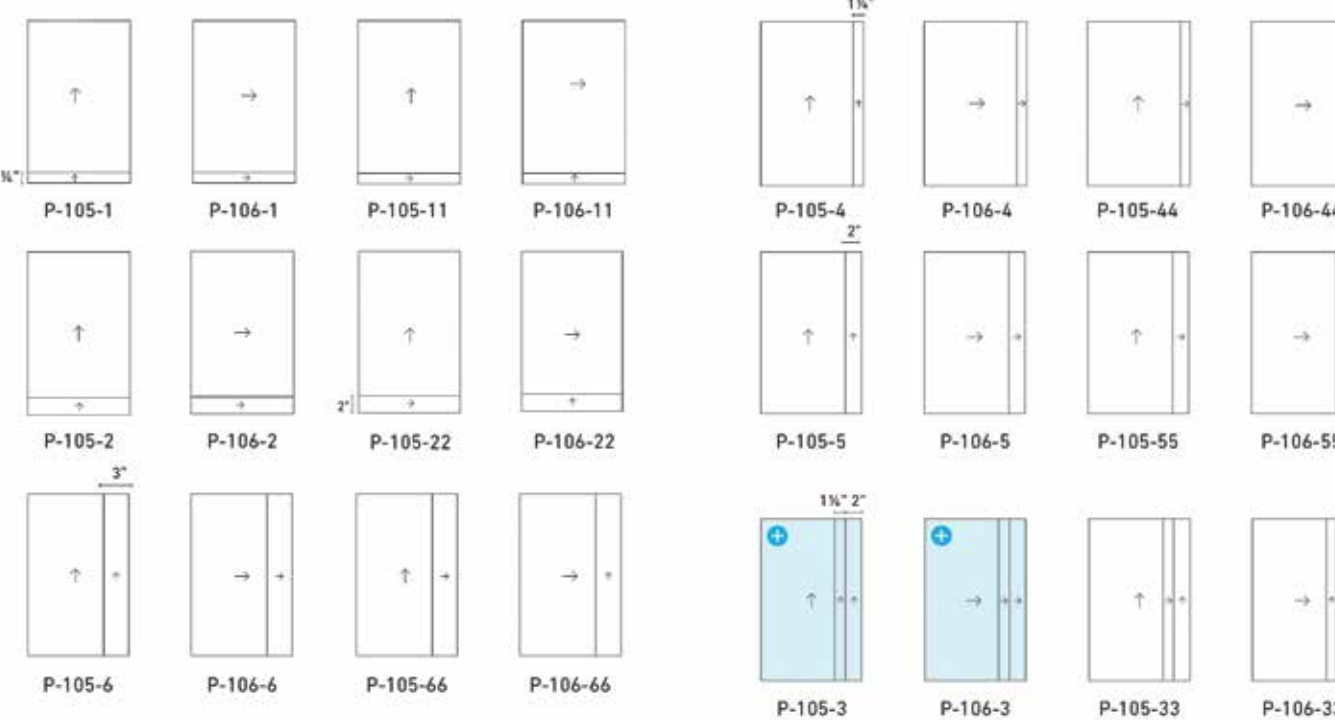

Façades / Drawers front

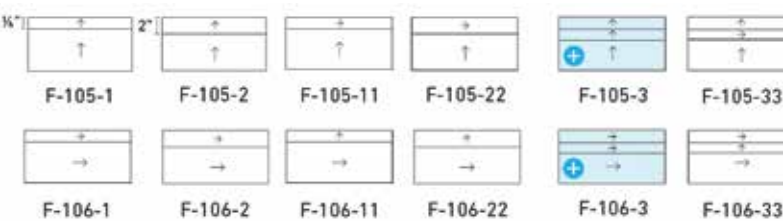

SÉRIE ÉLÉMENT / SERIE ELEMENT

Portes / Doors



Façades / Drawers front

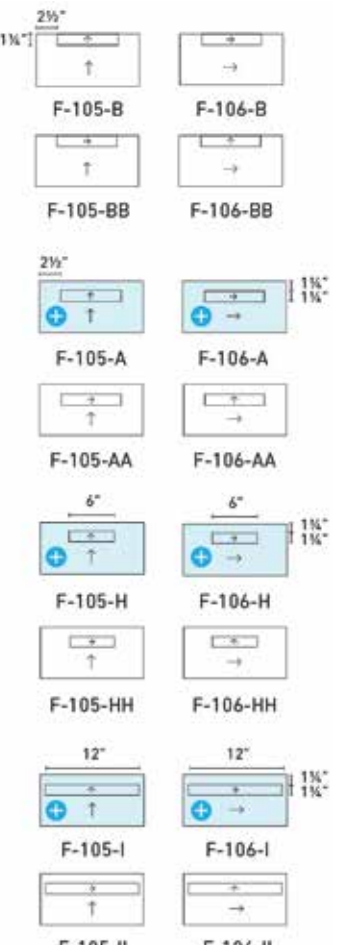

LÉGENDE LEGEND

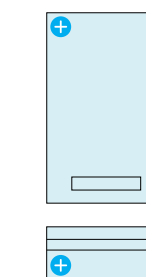

➕ OPTIONS D'INSERTION

LES PORTES IDENTIFIÉES PAR UN ➕ SONT DISPONIBLES AVEC L'OPTION D'INSÉRER UNE COULEUR SUPPLÉMENTAIRE. Référez-vous au guide des couleurs

NOMENCLATURE DE LA COMMANDE

Porte + Code de couleur + Code de couleur de l'insertion
Ex.: P-105-A-K18-0720

➕ INSERTION OPTIONS

INSERTION OPTIONS ARE AVAILABLE FOR THE DOORS IDENTIFIED BY ➕. Refer to the colours guide

ORDER PRODUCT CODE

Door + Color code + Insertion options color code
Ex.: P-105-A-L560-0720

